

# FIREMAGIC®

## Aurora Digital Thermometer

Model # 24180-12(H)

**INSTALLER:** Leave these instructions with consumer.  
**CONSUMER:** Retain for future reference.

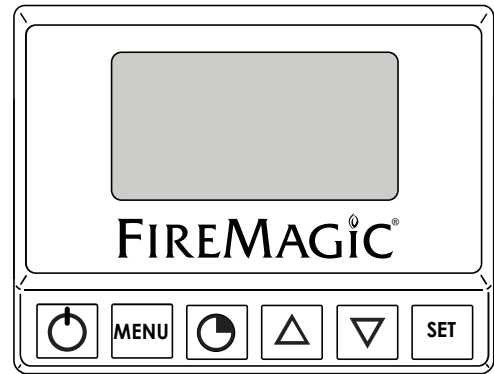

This digital thermometer is for replacement on an Aurora grill. To install, follow the steps below:

1. **Be sure the grill is completely cool.**
2. Locate the old thermometer on the grill control panel between the knobs. Remove it from the grill by slightly sliding it to the left, then lifting the right side outward until it clears the control panel.

**CAUTION:** Remove carefully as the wire harnesses will still be attached to the back of the thermometer.

3. The wire harness will be taped. CAREFULLY cut the tape.

**Important:** Take note of the way the harness is taped, as once the new thermometer is connected; the new harness will need to be similarly taped.

4. CAREFULLY push the end of the clip down and pull apart the wire harness at the connector, as shown in Fig. 1-1. **DO NOT** pull apart from the wires.

**CAUTION:** Pulling connection apart from the wires may cause damage to your unit.

5. If your grill control panel is equipped with a mirror panel, skip this step and proceed to step #6.

If your grill control panel IS NOT equipped with a mirror panel, apply the supplied gasket onto the thermometer by removing the protective sheet and pressing the adhesive side against the rear of the thermometer (see Fig. 1-1).

6. Connect the new thermometer wire harness to the exposed wire harness coming out of the grill (see Fig. 1-1).

**CAUTION:** The wire harness must be properly connected as shown in Fig. 1-2 (the clip and tab must align, allowing for an easy connection). **DO NOT FORCE** the connection together.

7. Ensure that the wire harness is properly taped using high temperature electrical tape.
8. Carefully install the thermometer into the cutout on the control panel.

This completes installation, refer to the following pages for digital thermometer operation.

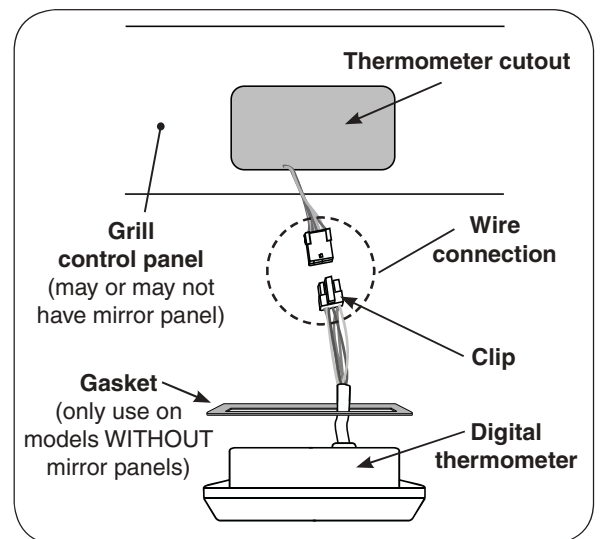

**Fig. 1-1** Removing / connecting digital thermometer

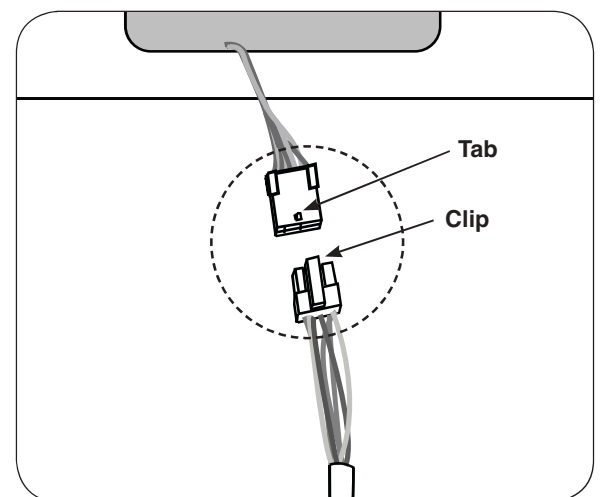

**Fig. 1-2** Proper connection

## OPERATION

Your grill comes with a digital thermometer for oven and meat probe temperature monitoring, and timed cooking. Pressing the power button will turn on the thermometer. The thermometer will automatically shut off after 5 minutes if no temperature change is detected.

The thermometer is located on the control panel between the control knobs.

Plug in the meat probe on the right side of the control panel as shown in Fig. 2-1. The thermometer battery access drawer is also located there, see Fig. 2-2 (if applicable, only on certain models).

**FOR BEST PERFORMANCE, GENTLY PRESS THE BUTTONS.** When turned on, accurate temperature readings will begin after the thermometer has initialized. When turned off, allow 5 seconds prior to turning back on.

Read the following sections completely regarding thermometer operation. Refer to Fig. 2-3 for thermometer orientation and button locations.

### DEFAULT SCREEN

**Press the power button to turn the thermometer ON.** The default screen will be displayed. Temperatures for the oven and meat probe will be shown (Fig. 2-4). See below for options under the default screen.

### Setting a Location Temperature

1. Press the up/down arrow to switch to the desired location (oven or meat probe). Press **SET**.
  2. The selected location's temperature screen will be displayed. Use the arrows to set the desired temp. The actual temp. will also be shown. (See Fig. 2-5.)
- Note: PRESSING the arrows will adjust the desired temp. by increments of one degree. HOLDING them down (for several seconds) will adjust the temp. rapidly.**
3. Press **SET** to return to the default screen. Repeat as necessary for other location.

The alarm will sound (if set to do so) when the oven / meat probe reaches its set temperature. The alarm is silenced by pressing any button on the thermometer.

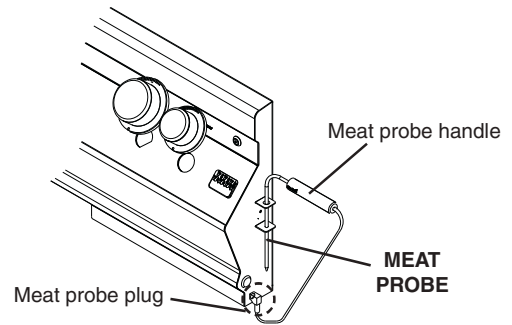

Fig. 2-1 Meat probe detail

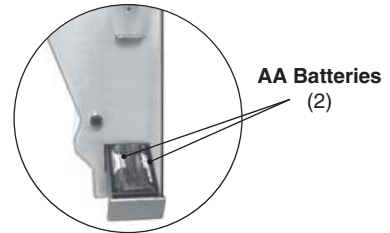

Fig. 2-2 Battery access (if applicable)

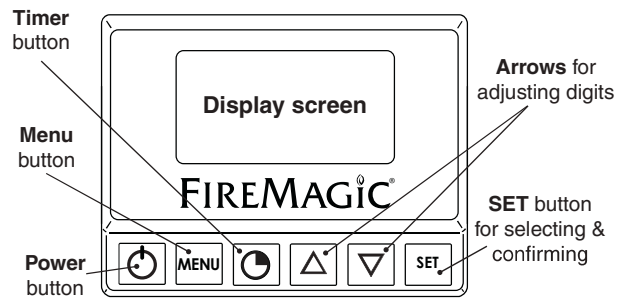

Fig. 2-3 Orientation

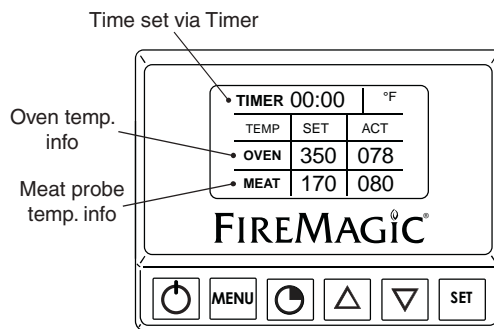

Fig. 2-4 Default screen detail

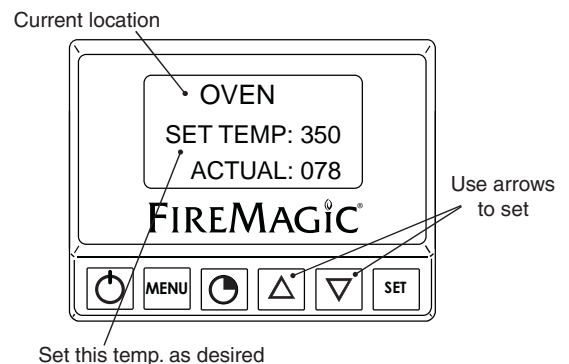

Fig. 2-5 Location temp. screen (oven shown)

## OPERATION (cont.)

### Setting the Timer

1. Press the timer button. Use the arrows to set the desired amount of time (see Fig. 3-1.)
2. Press **SET** to return to the default screen.

The time remaining will be shown on the default screen. Once the time reaches zero; the alarm will sound. The alarm is silenced by pressing any button on the thermometer.

### MENU SCREEN

Press the power button to turn the thermometer **ON**. The default screen will be displayed. Press the **MENU** button to display its screen. Press the up/down arrow to scroll through the options. (See Fig. 3-2.) See below for options under the menu screen.

**Note:** The menu screen will return to the default screen after approximately 30 seconds of no activity. Press the **MENU** button to manually return to the default screen.

### Changing temperature units (°C/°F)

1. Under the menu screen select **SETUP**. Press **SET**.
2. Press the up/down arrow to select **SETUP FC**. Press **SET**.
3. Press the up/down arrow to select the desired temperature unit (°C/°F).
4. Press **SET** to return to the menu screen.

### Grill Guide and Meat Probe

The grill guide displays recommended ready temperatures for various meats.

1. Under the menu screen select **GRILL GUIDE**. Press **SET**.
2. Press the up/down arrow to view the desired meat.
3. Note the temp. and press **SET**. This will take you to the meat probe temperature screen.
4. Use the arrows to set the noted temp.
5. Press **SET** to return to the default screen.

Putting the meat probe into the cooking meat will give an actual temp. reading. The alarm sounds (if set to do so) when the actual temp. reaches the set temp. The alarm is silenced by pressing any button on the thermometer.

**Note:** Do not leave the meat probe in the meat for a prolonged period of time, or with the hood closed.

**Note:** The meat probe is calibrated specifically for use at temperatures between 130°F and 180°F.

Set time as desired

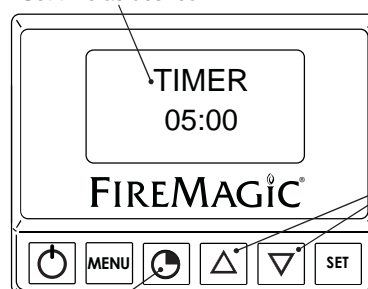

Fig. 3-1 Timer screen

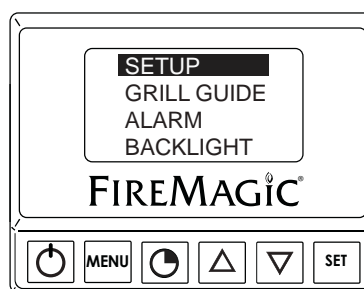

Fig. 3-2 Menu screen

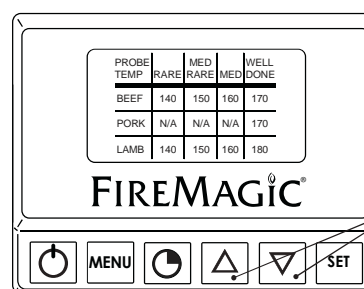

Fig. 3-3 Grill Guide screen

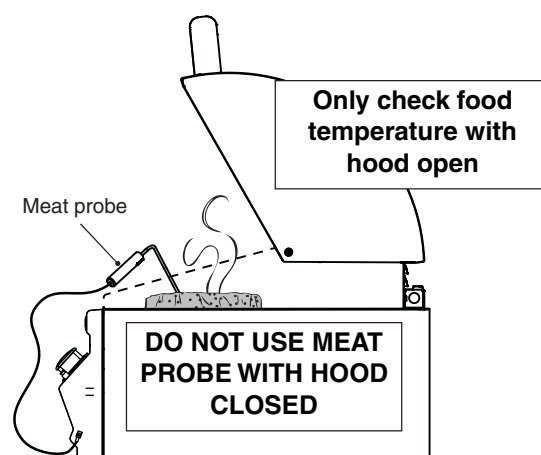

Fig. 3-4 Meat probe

## OPERATION (cont.)

### Setting the Alarm

The alarm can be individually set (ON or OFF) for the meat probe and oven temp. The default setting has the alarm OFF for the meat probe and oven temp. The alarm always sounds for the TIMER.

1. Under the menu screen select ALARM. Press **SET**.
2. Use the up/down arrow to select the desired alarm, and press the power button to turn the alarm ON/OFF.
3. Press **SET** to return to the menu screen.

### Setting the Thermometer Backlight

The default color for the thermometer backlight is blue. The color may be changed as desired by turning the three base colors ON/OFF. Various combinations will result in different colors.

1. Under the menu screen select BACKLIGHT. Press **SET**.
2. Use the up/down arrow to select the desired color, and press the power button to turn the color ON/OFF.
3. Press **SET** to return to the menu screen. The new color will be displayed.

**Note:** Turning all colors OFF will result in no backlight.

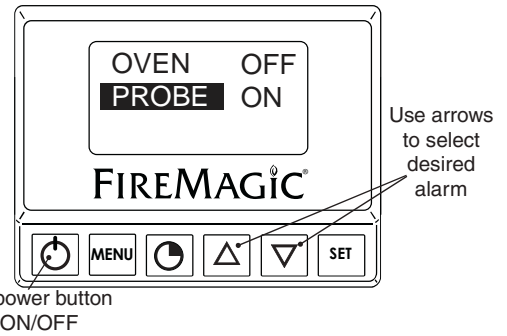

**Fig. 4-1** Alarm screen

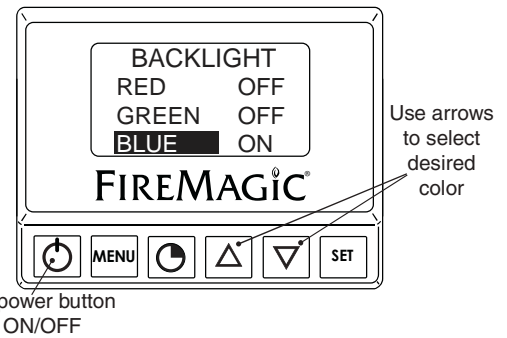

**Fig. 4-2** Backlight screen